

PoE Outdoor Switch

Datasheet

PT-POS8PB2SM-OT

PT-POS8PB2SM-RS-OT



Contents

1 Product Introduction	05
1.1 Product Positioning.....	05
1.2 Product Features.....	05
1.3 Product Appearance.....	07
1.4 Product Temperature Derating Curve.....	11
2 Product Specifications	12
2.1 Electrical Parameters.....	12
2.2 PoE Characteristics.....	12
2.3 Switching Characteristics.....	13
2.4 Physical Characteristics.....	13
2.5 Environmental Parameters.....	14
2.6 Certification Standards.....	14
2.7 Management Interface.....	14
3 Installation Preparation	16
3.1 Items Required for Installation.....	16
3.2 Equipment Inspection.....	16
4 Installation Guide	19
4.1 Pole-Mounted Installation.....	19
4.2 Clamp Installation.....	21
4.3 Fixed Installation.....	22
4.4 Grounding Installation.....	24
4.5 Interface Connection.....	25
5 Accessory Information	31

Declaration

Copyright Notice

Copyright ©2025 Creative Lianjie Network Technology Co.Ltd

All rights reserved.

Without the prior consent of PROCET, no organization or individual is permitted to imitate, reproduce, plagiarize, or translate any part or all of this manual, nor to distribute it in any form (electronic, photocopying, recording, etc.) for commercial purposes.

This product complies with environmental protection design standards. Please do not dispose of this product as household waste. Users are advised to separate this product from domestic waste at the time of disposal. Proper waste classification will contribute to the conservation of natural resources and the reduction of environmental pollution.

Trademark Notice

PROCET is a registered trademark of Beijing Creative Lianjie Network Technology Co., Ltd.

All other trademarks or registered trademarks mentioned in this document are the property of their respective owners.

Disclaimer

The products, services, or features you purchase are governed by the commercial contracts and terms of PROCET. The content of this document may not fall within the scope of your purchase or use. Unless otherwise specified in the contract, PROCET makes no express or implied representations or warranties regarding the contents of this document.

Due to product updates or other reasons, the contents of this document are subject to change without prior notice, and any necessary corrections will be incorporated in subsequent versions. Unless otherwise agreed, this document is provided for guidance only and does not constitute any express or implied warranty.

Document History

Version	Date	Notes
v1.0	2025/05/21	First Version Release

For Whom

This manual is intended for:

Network Engineers

Network Administrators

Field Technicians

Model Comparison Chart

Item	PT-POS8PB2SM-OT	PT-POS8PB2SM-RS-OT
PoE Standard	IEEE802.3af Power over Ethernet IEEE802.3at Power over Ethernet IEEE802.3bt Power over Ethernet	
Ports	AC*1 SFP*2 PoE*8 Grounding*1	AC*1 SFP*2 PoE*8 DC&485*1 Grounding*1
Op. Temp.	-40°C-65°C	
SP	Common Mode: 6KV Differential Mode: 1.5KV	
Power Pins	4/5(+),7/8(-) & 3/6(+),1/2(-)	
Network Manage	Support 802.1Q VLAN,Support MAC Address , Auto-Learning and Aging Cable Detection	
OCP	Each PoE-out Port is Equipped with Maximum Current Protection	
IP Rate	IP67	
Size	309mm(including 337mm with Protective Cover) X 235mm X 93mm	

1 Product Introduction

1.1 Product Positioning

The PT-POS8PB2SM-OT/PT-POS8PB2SM-RS-OT series of PoE outdoor switches strictly adhere to industrial - grade design standards. They are specifically developed for key network deployment scenarios in complex and harsh outdoor environments, covering application fields such as security monitoring systems (e.g., intelligent traffic cameras, border protection devices), outdoor network projects (e.g., smart city streetlight gateways, industrial IoT terminal aggregation), and remote device power supply (e.g., edge computing nodes, meteorological monitoring sensors). The products focus on high - reliability PoE power supply and high - speed data transmission to ensure continuous, stable, and reliable operation in various outdoor environments.

Strengthens network and power management capabilities. It is equipped with lightweight network management functions, supports refined port configuration, dynamic power allocation, and centralized device monitoring. It is suitable for large and complex network architectures and meets the needs of users who require power resource optimization and remote fault diagnosis.

1.2 Product Features

PoE Power Supply Management: Supports independent power configuration for each port (maximum 90W per port, with a maximum total power of 330W for 8 PoE ports), scheduled task plans (such as powering on/off by time period), and an over - current protection mechanism to prevent device damage due to abnormal load.

Network Management: Integrates 802.1Q VLAN division (supporting 4096 VLAN IDs), MAC address auto - learning (with a capacity of 16K) and aging functions, and has a cable detection function. It also features four - level traffic priority scheduling based on ports and supports broadcast storm suppression.

DC&485 Port Expansion: Equipped with a multifunctional port that supports dual - channel RS485 interfaces, compatible with industrial sensor data collection and transparent transmission settings, meeting the diverse power supply and communication requirements of IoT devices; 12/24Vdc adjustable output.

Localized Software Upgrade: Through the localized web - based WEB terminal, software can be automatically updated.

Electrical Protection System: PoE ports have 6kV common - mode / 1.5kV differential - mode surge protection (in line with IEC 61000 - 4 - 5 standard), and AC ports have 6kV common - mode / 1.5kV differential - mode surge protection.

Electrostatic Protection: 6kV contact discharge / 8kV air discharge electrostatic protection (IEC 61000 - 4 - 2).

Power Supply: 350W, MTBF (217514h)

Wide - Temperature Operation: Supports a wide - temperature operating range of - 40°C ~ + 65°C. It can start at full load at - 40°C in a cold - start state and still operate at full load at an ambient temperature of 65°C.

Protection Level: IP67 protection level.

Robust Structure Design: Adopts an integrated cast aluminum alloy housing with a white electrostatic spray - painted surface, meeting the 1K10 anti - collision standard.

Air Pressure Balance and Protection Details: 304 stainless - steel pressure relief valve, 160ml/min@12kpa; ports are equipped with metal seals and waterproof rubber plugs to prevent moisture intrusion from the source.

Heat Dissipation Design: Adopts an overall cast aluminum process and a fan - less heat dissipation design to extend the MTBF value of the device.

Multi - Scenario Adaptable Installation: Provides multiple installation methods such as pole - mounting (for pole diameters $\phi 70 - 110\text{mm}$), wall - mounting, and clamping. It is equipped with special installation kits (including lifting ropes, brackets, and protective covers), suitable for diverse outdoor scenarios such as poles, equipment boxes, and building facades.

Protective Cover Installation: The protective cover design effectively protects the interfaces from wind and rain, optimizes cable storage, improves the aesthetic degree of the project, and enhances the anti - aging and anti - ultraviolet capabilities of the lines.

Green Design: Complies with the RoHS environmental protection standard, strictly limiting the use of harmful substances such as lead and mercury; packaging and accessories use recyclable materials to reduce the environmental burden.

1.3 Product Appearance

- Perspective View

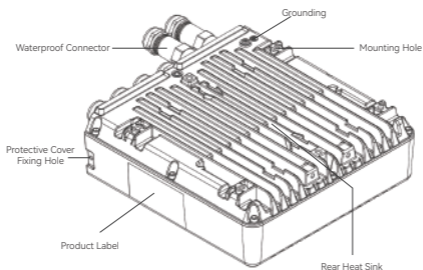

• Perspective View (Installed)

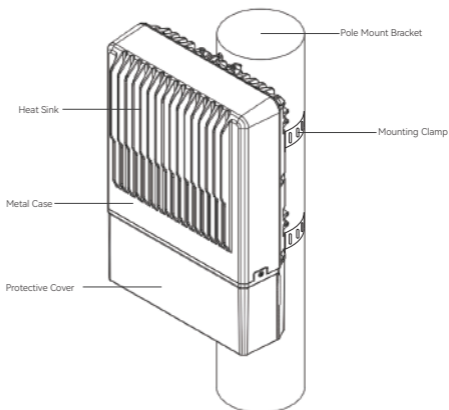

• Side View

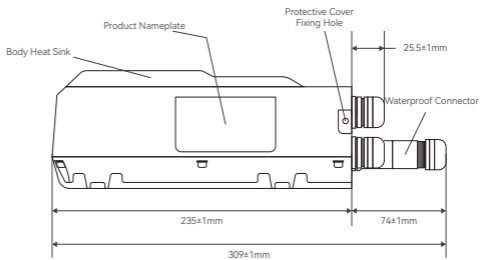

- Bottom View

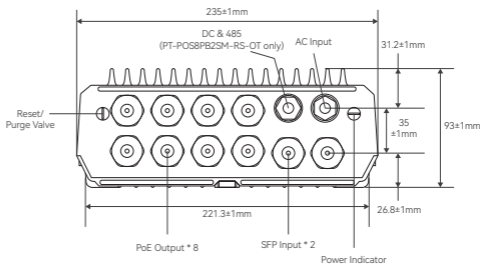

Protective Cover Dimensions: As shown in the following figure.

- Front View

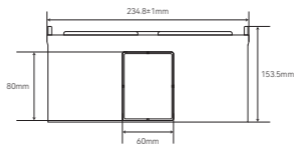

- Bottom View

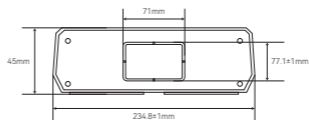

Port Indicator Lights (including all product indication states), with status descriptions as follows:

Item	Status	Description
Power Indicator	Solid Green	The device is powered on and can operate normally.
	Off	The device is not powered on or the power - on fails.
Data Indicator	Solid Yellow	Data Connection
	Blinking Yellow	Data is being transmitted
	Off	The port is not connected to the device or the connection fails.
PoE Indicator	Solid Green	PoE power supply.
	Blinking Green	Detecting load.
	Off	The port is not connected to the device or the connection fails.

1.4 Product Temperature Derating Curve

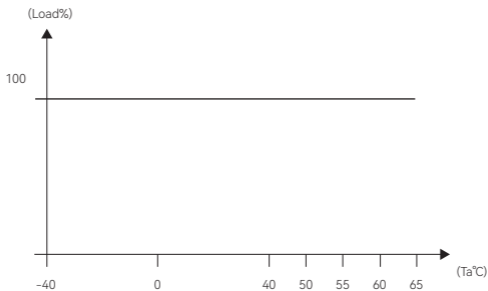

230V Load Loss(%>@Temperature(°C)

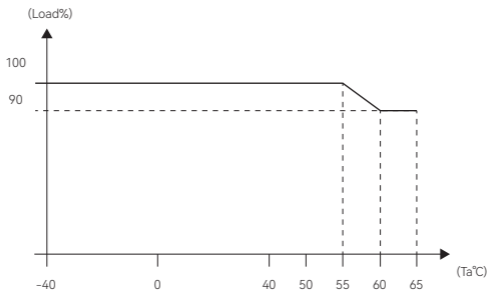

115V Load Loss(%>@Temperature(°C)

2 Product Specifications

2.1 Electrical Parameters

Item	PT-POS8PB2SM-OT	PT-POS8PB2SM-RS-OT
Ports	AC*1 SFP*2 PoE*8 Grounding*1	
DC&485 Port	-	8PIN interface, 2PIN DC port provides 12Vdc/24Vdc switching option, 2 * 2PIN RS485 interfaces, 2 * EARTH
Input	110-240Vac 350W	
Output	Total power 330W Max (including DC & 485 port)	
DC Output	12/24Vdc 2A 48W(Max)	
IPC	<20W	
Surge Protection	Protected Lines: 1,2,3,4,5,6,7,8 Common-mode Protection Level I(10/700us): 6KV Differential-mode Protection Level I(10/700us): 1.5KV	
ESD Protection	6kV contact discharge; 8kV air discharge, Standard: IEC61000 - 4 - 2	
MTBF	217514h	

2.2 PoE Characteristics

Item	PT-POS8PB2SM-OT	PT-POS8PB2SM-RS-OT
PoE Standard	IEEE802.3af Power over Ethernet IEEE802.3at Power over Ethernet IEEE802.3bt Power over Ethernet	
Power Pins	4/5(+),7/8(-) & 3/6(+),1/2(-)	
PoE Output	55Vdc 1.64A 90W Max per port Total power 330W Max	

2.3 Switching Characteristics

Item	PT-POS8PB2SM-OT	PT-POS8PB2SM-RS-OT
Switching Mode	Store-and-Forward	
VLAN	Support 4096 VLAN IDs Support 802.1Q VLAN Support VLAN based on any combination of ports across multiple chips	
Network Protocols	IEEE802.3i/IEEE802.3u/IEEE802.3ab /IEEE802.3z/IEEE802.3bz	
Data Rate	RJ45: 100/1000Mbps, SFP: 1000/2500Mbps	
BBW	26Gbps	
MAC Capacity	16K	
PF Rate	19.344Mpps	
MAC Address Table	Follow IEEE 802.1d standard Support MAC address auto - learning and aging	
QoS	Support high - speed, non - blocking four - traffic - class QoS structure	

2.4 Physical Characteristics

Item	PT-POS8PB2SM-OT	PT-POS8PB2SM-RS-OT
Housing Material	Aluminum alloy (metal seals + waterproof rubber plugs)	
Install Method	Pole - mounting ($\phi 70 - 110\text{mm}$)/ Wall - mounting (expansion screws)	
IP Rate	IP67 (dust - proof and waterproof)	

Item	PT-POS8PB2SM-OT	PT-POS8PB2SM-RS-OT
Size	309mm (including 337mm with protective cover) X 235mm X 93mm	
Weight	4650g	

2.5 Environmental Parameters

Item	PT-POS8PB2SM-OT	PT-POS8PB2SM-RS-OT
Op. Temp	-40°C to 65°C	
Op. Humid.	5%-95%, non - condensing	
Op. Altitude	Below 5000 meters	
Stor. Temp.	-40°C to 85°C	
Stor. Humid.	10%-90%, non - condensing	
IP Rate	IP67	

2.6 Compliance Certifications

Safety Standard: IEC 60950-22 (Information Technology Equipment Safety)

EMC Standards: CE, FCC (Electromagnetic Compatibility)

Environmental Standard: RoHS (Restriction of Hazardous Substances)

2.7 Web Interface

After connecting the device, enter the login device IP address (e.g., 192.168.31.192) in the browser address bar. The displayed page is as shown below. Enter the account: admin; password: 123123; to enter the device page. Note: The IP of the login computer needs to be in the same network segment as the login device (e.g., 192.168.31.*).



After successful login, the displayed page is as follows, with modules such as Home, VLAN Configuration, Switch Management, Monitoring, Quality of Service, PoE Settings, Power Supply Settings, Transparent Transmission Settings, Scheduled Tasks, and System Management.



Simple VLAN division can meet different requirements and achieve directed communication.

The PoE power - supply status can be displayed; PoE power - supply can be controlled: click the "Normal" button for normal PoE power - supply, click the "Force" button for forced PoE power - supply, and click the "Off" button for forced PoE power - off.

For detailed software operation instructions, please refer to the software user manual.

3 Installation Preparation

3.1 Items Required for Installation

When installing the device, the following items are required. These items are assembled in the product packaging box.

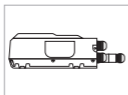

PT-POS8PB2SM-OT



Operating Manual

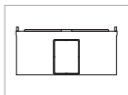

Product Protective Cover

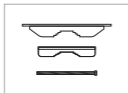

Installation Kit



Waterproof Connectors

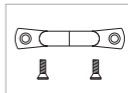

Handles

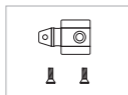

Fasteners

3.2 Equipment Inspection

Before installing the device, please connect the device to the power supply first to check whether it can operate normally.

Connect the power supply using the AC port, connect the SFP port to a switch to provide a network. When using standard PoE power - supply, connect the PoE port to a PD device that supports the PoE power - supply function, such as a PoE - enabled camera, as shown in below.

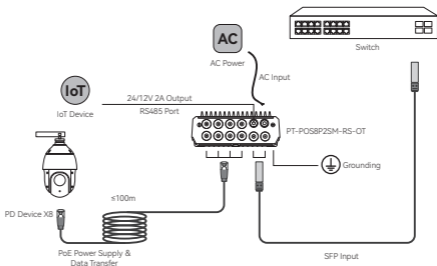

Notice:



- Wear gloves during installation.
- Do not install the device with power on.
- The external paint of the device should be kept intact. If there is paint peeling, the peeled part needs to be repainted immediately to prevent corrosion.
- When fixing the large pole - mounting parts, ensure that the clamp is tightly attached to the pole body and there is no foreign matter between the clamp and the pole body.
- Before using the device, please read the instruction manual carefully and operate it in a standardized manner.
- This device needs to be grounded when in use.
- When using this device outdoors, please use shielded network cables to avoid the impact of the outdoor environment on network quality.
- Do not place this device on an unstable box or table. Once it falls, it will cause serious damage. When choosing pole - mounting installation, it should be fixed properly.
- Sufficient space (more than 5cm) should be reserved around this device for normal heat dissipation.



- Do not place heavy objects on this device.
 - Since the device itself is relatively heavy, it is recommended to equip a load - bearing lifting rope during installation to ensure the operation safety during the device installation process.
-

4 Product Installation

This product is suitable for safe use by methods such as pole - mounting.

4.1 Pole-Mounted Installation

The device mainly achieves waterproof and stable operation through pole - mounted installation. If it is in a harsh outdoor environment, please install the protective cover properly.

Installation Step 1: Use 4PCS M5 × 25 bolts and M5 nuts to install 2 large brackets on the back of the product through the round holes, as shown in below.

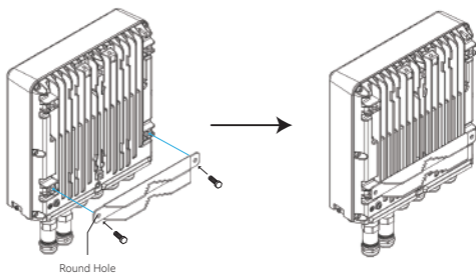

Installation Step 2: Use 4PCS M6×150 bolts and M6 nuts to fix the product on a suitable pole through the rectangular holes, as shown in below.

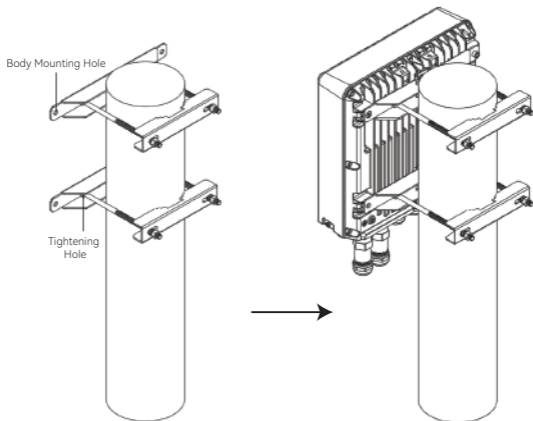

Installation Step 3: Tighten the screws to complete the installation.



Note:

For better protection of outdoor PD, it is recommended to install the protective cover properly.

4.2 Clamp Installation

Installation Step 1: Use M6 screws to install 2 fixing accessories into the upper and lower installation holes at the bottom of the fuselage.

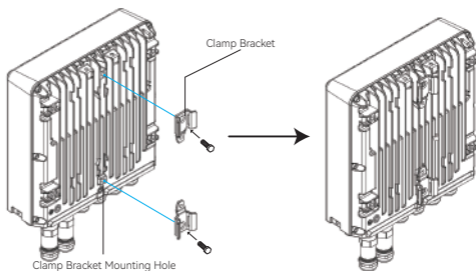

Installation Step 2: Pass a stainless - steel clamp with a size less than 17mm through the perforations on both sides of the fixing accessories, and fix the device on a vertical pole with a diameter of 70 - 110mm. Tighten the fixing screws.

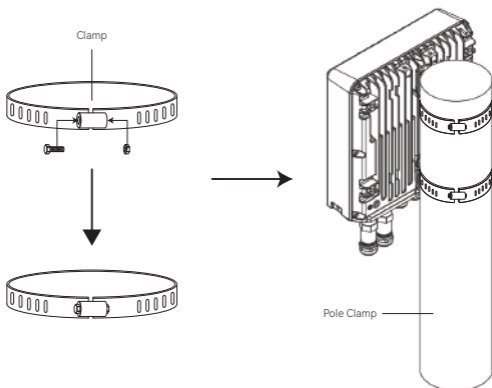

4.3 Fixed Installation

Installation Step 1: Use the positioning paper to mark the hole positions on the wall. Drill the holes and insert expansion bolt.

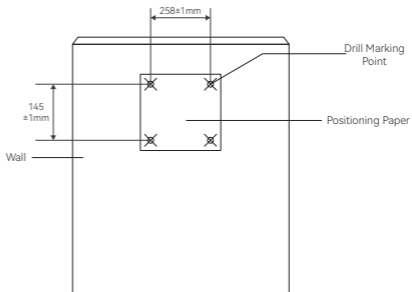

Installation Step 2: Secure 4 mounting brackets to the 4 corner holes on the bottom of the unit using M6 screws.

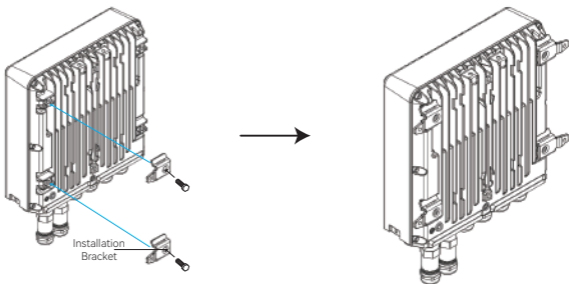

Installation Step 3: Align the bracket holes with the wall and fasten using appropriate mounting screws.

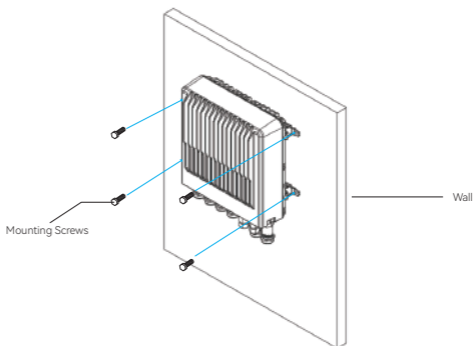

4.4 Grounding Installation

The methods for solving grounding problems summarized during the large - scale construction of PROCET outdoor PoE switch PT-POS8PB2SM-OT are as follows, for reference only in the grounding construction of this product:

If this product is installed in a computer room, it can be connected to the special grounding busbar in the computer room. The grounding busbar is a connecting conductor between the building's grounding bodies. Currently, there are flat iron, flat steel, nano - material conductors, copper - clad steel, etc. Connect the device to the grounding busbar with a grounding wire, as shown in below.

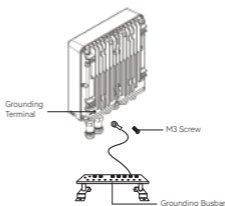

In an environment without special grounding equipment, for the safety of personnel and equipment, we can build a simple ground (as shown in below):

Prepare a 6 mm grounding wire or braided soft copper wire.

Prepare a copper pipe, angle iron, or other metal pipe and bury it more than one meter underground as a ground wire.

Use the grounding wire to connect the grounding terminal outside the product to the metal pipe (or angle iron).

Note:



If there is really no available environment, you can choose to connect a galvanized metal pipe buried more than one meter underground for emergency grounding, such as a sewage pipe or a drainage pipe, according to the method of simple grounding.

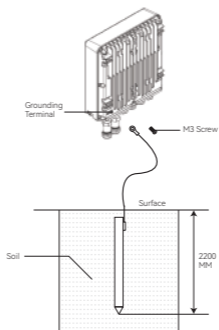

4.5 Interface Connection

8 PoE Ports (as shown in below):

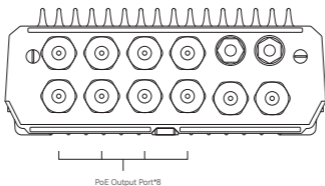

Connection Step 1: Unscrew the metal sealing parts on the PoE port of this product in a counterclockwise direction and remove them. There are a total of five sealing parts to be removed. One end is taken as an example here.

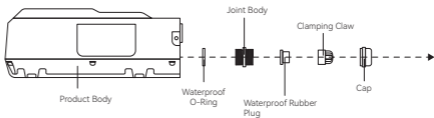

Connection Step 2: Slip the metal sealing part accessories onto the RJ45 cable in the following order. The waterproof rubber plugs are all laterally provided with slits, through which the cable can be placed into the central through-hole of the plug. Then insert the network cable with a waterproof connector into the interface of this product.

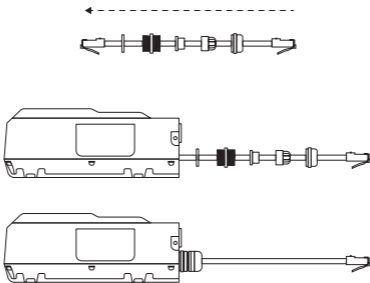

Connection Step 3: Tighten all the sealing sleeves until the rubber plugs tightly wrap the cable.

AC Port Connection Schematic Diagram (as shown in the following figure):

The AC input port is connected by screw terminals. There are indicator lights on the AC input port to display the pin definitions. Three pins are marked as: Ground, N (Neutral), and L (Line).

The diameter of the AC power cord is 4.5 - 12mm. Strip off 2.5mm of the cable sheath and 1mm of each wire sheath, and pass the power cord through the waterproof cap.

Insert the wire into the correct pin port and fix the wire to each pin with a straight - bladed screwdriver.

Slide the waterproof gland over the pins of the AC input port and tighten it by hand onto the housing.

The following table lists the AC power cable specifications.

Parameter	Value
Recommended cable type	North America - SJOW or SOOW
	Worldwide - H05RN-F or H07RN-F
Voltage rating	300V (or better recommended)
Temp. range	-40°C to 65°C (or better recommended)
Cable size	16 AWG - 18 AWG 3C
	1.0mm ² - 1.5 mm ² 3C
Cable outer dimension	Diameter: 3/16 in.-3/8 in.
	Diameter: 5.0 mm-9.5 mm
	Approved for indoor and outdoor applications.

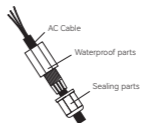
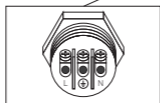
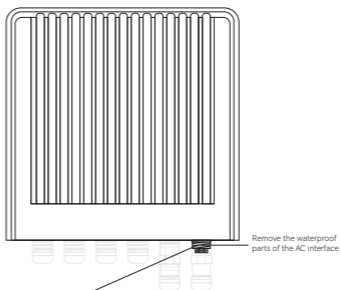
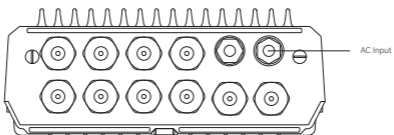

SFP Port (as shown in below):

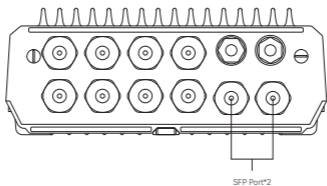

Connection Step 1: Unscrew and remove the metal sealing parts on the SFP port of this product in a counterclockwise direction. There are a total of five sealing parts to be removed, with one end used as an example here.

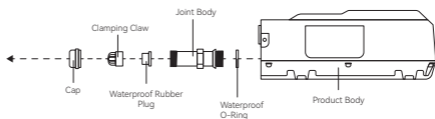

Connection Step 2: Slide the metal sealing part accessories onto the optical fiber cable in the following order. The waterproof rubber plugs are all laterally equipped with slits, allowing the cable to be inserted into the central through-hole of the plug via the slit. Then insert the network cable with a waterproof connector into the product's interface.

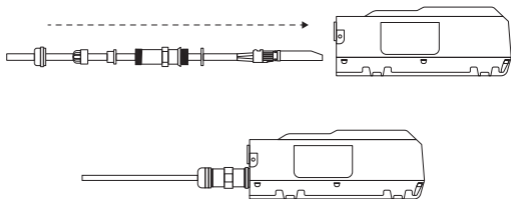

Connection Step 3: Tighten all sealing sleeves until the rubber washers tightly wrap around the optical fiber cable.

Note: The SFP cable must be of outdoor - use grade.

DC & RS485 Port (See as below figure)

The PIN definitions are as follows in the table:

PIN #	Definition	Remarks
1	12/24V-	DC negative Pole
2	B1	PIN for RS485-2 signal
3	B2	PIN for RS485-2 signal
4	EARTH	RS485 ground pin
5	A2	PIN for RS485-1 signal
6	A1	PIN for RS485-1 signal
7	12/24V+	DC positive pole
8	EARTH	RS485 grounding pin

Connection Step 1: Rotate and remove the seal on the DC&485 port of this product in a counterclockwise direction.

Connection Step 2: Use an 8 - core cable to connect each pin as shown in the table above.

Connection Step 3: Tighten the seal cover until the rubber washer tightly wraps the 8 - core cable.

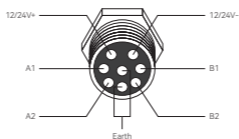

5 Accessory Information

The dimensions of the waterproof parts are shown in the following figure (unit: mm).

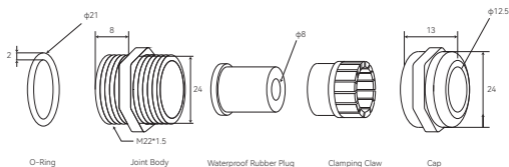

The diameter range of the installation kit is shown in below.

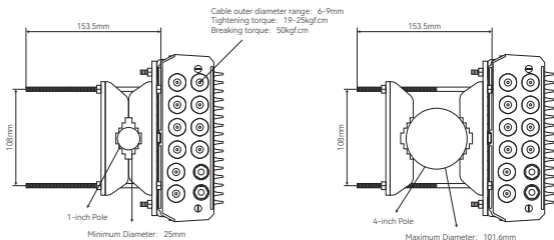

The dimensions of the protective cover are shown in below.

- Front View

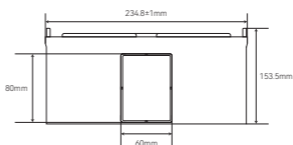

- Bottom View

